



SONOMA FORGE
DESIGNER FAUCETS

2024

RETAIL PRICE LIST

EFFECTIVE JAN 1, 2024

Subject to Change without Notice

www.sonomaforge.com

info@sonomaforge.com

800-330-5553

TABLE OF CONTENTS

		PAGE
WATERBRIDGE	LAVATORY & TUB FAUCETS	4-7
	EXPOSED SHOWERS	8-16
	FOOT WASHES	17
	EXPOSED SHOWER OPTIONS	18-19
	ACCESSORIES	20-21
WHEREVER	LAVATORY & TUB FAUCETS	22-23
	CONCEALED SHOWER CONTROLS	24
	CONCEALED SHOWER OPTIONS	25-26
HANDSHOWERS	HANDSHOWER KITS	27 & 32
CIXX	FAUCETS & ACCESSORIES (While supplies last)	28
	CONCEALED SHOWERS & ACCESSORIES (While supplies last)	29
STRAP	FAUCETS & ACCESSORIES	30
	CONCEALED SHOWER CONTROLS	31
	CONCEALED SHOWER PARTS	32-33
SANS HANDS	SENSOR FAUCETS	34-35
KITCHEN, BAR, & PREP FAUCETS	BRUT	36-37
	WATERBRIDGE	38
	CUVEE & WINGNUT	39
	BROWNSTONE (For a limited time)	40
	POINT OF USE FAUCETS	41
DRAINS	KITCHEN DRAINS & ACCESSORIES	42
	LAVATORAY & BATHTUB DRAINS	43
	FLOOR / SHOWER DRAINS	44
MISC. PARTS	MISCELLANEOUS & REPLACEMENT PARTS	45
INDEX	PRODUCT INDEX BY MODEL NUMBER	46
TERMS & CONDITIONS	TERMS & CONDITIONS & WARRANTY	47

PLEASE VISIT OUR WEBSITE FOR COMPLETE TERMS AND CONDITIONS

ORDERING SONOMA FORGE PRODUCTS

INTRODUCTION TO SONOMA FORGE PRODUCT CODES

Sonoma Forge is sold exclusively through a network of authorized showrooms, which can be found on our website. Our part numbers use the following codes, mostly abbreviating the following information: Collection, Application, Spout Style, Size, and Finish.

COLLECTION

BRUT	= Brut
BS	= Brownstone
CV	= Cuvee
CX	= Cixx
SANS	= Sans Hands (sensor faucets)
ST	= Strap
WB	= Waterbridge
WE	= Wherever
WN	= Wingnut

TYPE

ACC	= Accessory
LAV	= Lavatory Faucet
FW	= Foot Wash
HS	= Hand Shower
RTF	= Tub Faucet
SHW	= Shower / Shower Accessory

APPLICATION

DM	= Deck Mounted
FM	= Floor Mounted
WM	= Wall Mounted

SPOUT STYLE

GN	= Gooseneck
CAP	= Cap
FX	= Fixed
LBO	= Elbow
LG	= Large Gooseneck
SQ	= Square
SW	= Swiveling
WF	= Waterfall

SIZE (if applicable)

S	= Short
T	= Tall
L	= Long
LG	= Large

STANDARD FINISH CODES (Only for)

AB	= Antique Bronze	(Brownstone Collection)
B	= Brass	(CiXX Collection)
ORB	= Oil Rubbed Bronze	
MB	= Matte Black	
RC	= Rustic Copper	
RN	= Rustic Nickel	
S	= Stainless Steel	(CiXX Collection)
SN	= Satin Nickel	

HANDLE & DRAIN OPTIONS

"Tee" handles are standard for the Waterbridge and Wherever Collections.

Cross handles are available by special order. Handles listed herein are price per piece.

Most lav faucets include a drain. If a specific drain is preferred, simply note on your faucet order.

Prices listed are for standalone or replacement drains.

Kitchen and sensor faucets do not include drains.

AVAILABILITY

To service customers better, we attempt to maintain inventory of our most popular product/finish combinations.







For current availability, it is most efficient to email Sonoma Forge at: info@sonomaforge.com

SPECIAL ORDER FINISHES & CUSTOM PRODUCTS

Please contact us regarding custom products and non-standard finishes.

Special order and custom products are not returnable.

WATERBRIDGE LAV FAUCETS

PHOTO	DESCRIPTION	PART NUMBER	LIST PRICE
	<p>WALL MOUNT LAV FAUCET WITH WATERFALL SPOUT</p> <p>8" SPREAD, CENTER TO CENTER 10" REACH, WALL TO TIP 4" DROP, CENTER TO SPOUT TIP</p>	WB-LAV-WM-WF	\$2060
	<p>SHORT DECK MOUNT LAV FAUCET WITH WATERFALL SPOUT</p> <p>8" SPREAD, CENTER TO CENTER 2-1/4" SPOUT HEIGHT 7-3/4" CENTER TO SPOUT TIP</p>	WB-LAV-DM-WF-S	\$1890
	<p>TALL DECK MOUNT LAV FAUCET WITH WATERFALL SPOUT</p> <p>8" SPREAD, CENTER TO CENTER 6-1/2" SPOUT HEIGHT 7-3/4" CENTER TO SPOUT TIP</p>	WB-LAV-DM-WF-T	\$1890
	<p>FLOOR MOUNT LAV FAUCET WITH WATERFALL SPOUT</p> <p>8" SPREAD, CENTER TO CENTER 7-3/4" CENTER TO SPOUT TIP 29-1/2" SPOUT HEIGHT</p> <p>* TUB FILLER ON NEXT PAGE</p>	WB-LAV-FM-WF	\$2490
	CUSTOM HEIGHT	WB-LAV-FM-WF-CSTM	\$3490
	<p>OPTIONAL CROSS HANDLE SOLD INDIVIDUALLY</p>	WE-HNDL-C	\$120
	<p>RISER EXTENSION KIT FOR WATERBRIDGE DECK FAUCETS</p> <p>ADJUSTABLE FROM 1/2" TO 2-1/2"</p> <p>SOLD AS PAIR</p>	WB-ACC-LEG-EXT	\$270

WATERBRIDGE TUB FILLERS

PHOTO	DESCRIPTION	PART NUMBER	LIST PRICE
	<p>WALL MOUNT TUB FILLER WITH WATERFALL SPOUT</p> <p>8" SPREAD, CENTER TO CENTER 10" REACH, WALL TO TIP 2" DROP, CENTER TO TIP</p>	WB-RTF-WM-WF	\$2160
	<p>WALL MOUNT TUB FILLER WITH WATERFALL SPOUT & HANDSHOWER</p> <p>8" SPREAD, CENTER TO CENTER 10" REACH, WALL TO TIP 3" RISE, CENTER OF INLETS TO SPOUT TIP</p>	WB-RTF-WM-WF-HS	\$5150
	<p>DECK MOUNT TUB FILLER WITH WATERFALL SPOUT</p> <p>8" SPREAD, CENTER TO CENTER 6-1/2" SPOUT HEIGHT 7-3/4" CENTER TO TIP</p>	WB-RTF-DM-WF	\$2160
	<p>FLOOR MOUNT TUB FILLER WITH WATERFALL SPOUT</p> <p>8" SPREAD, CENTER TO CENTER 7-3/4" CENTER TO TIP 29-1/2" SPOUT HEIGHT</p> <p>SEE PAGE 43 FOR TUB DRAINS</p>	WB-RTF-FM-WF	\$2490
	CUSTOM HEIGHT	WB-RTF-FM-WF-CSTM	\$3490
	<p>FLOOR MOUNT TUB FILLER WITH WATERFALL SPOUT & HANDSHOWER</p> <p>8" SPREAD, CENTER TO CENTER 7-3/4" CENTER TO SPOUT TIP 32" SPOUT HEIGHT</p> <p>SEE PAGE 43 FOR TUB DRAINS</p>	WB-RTF-FM-WF-HS	\$5350
	CUSTOM HEIGHT	WB-RTF-FM-WF-HS-CSTM	\$6350
	<p>OPTIONAL STABILIZER TEE FOR FLOOR-MOUNTED FAUCETS</p> <p>ATTACHES TO WALL, TUB, OR FLOOR 16" CENTER TO END CAN BE CUT TO LENGTH</p>	WB-ACC-TEE	\$575





WATERBRIDGE LAV FAUCETS

PHOTO	DESCRIPTION	PART NUMBER	LIST PRICE
	<p>WALL MOUNT LAV FAUCET WITH ELBOW SPOUT</p> <p>8" SPREAD, CENTER TO CENTER 10" REACH, WALL TO TIP 4" DROP, CENTER TO TIP</p>	WB-LAV-WM-LBO	\$2060
	<p>SHORT DECK MOUNT LAV FAUCET WITH ELBOW SPOUT</p> <p>8" SPREAD, CENTER TO CENTER 2-1/4" SPOUT HEIGHT 7-3/4" CENTER TO TIP</p>	WB-LAV-DM-LBO-S	\$1890
	<p>TALL DECK MOUNT LAV FAUCET WITH ELBOW SPOUT</p> <p>8" SPREAD, CENTER TO CENTER 6-1/2" SPOUT HEIGHT 7-3/4" CENTER TO TIP</p>	WB-LAV-DM-LBO-T	\$1890
	<p>FLOOR MOUNT LAV FAUCET WITH ELBOW SPOUT</p> <p>8" SPREAD, CENTER TO CENTER 7-3/4" CENTER TO TIP 29-1/2" SPOUT HEIGHT</p> <p>* TUB FILLER ON NEXT PAGE</p>	WB-LAV-FM-LBO	\$2490
	CUSTOM HEIGHT	WB-LAV-FM-LBO-CSTM	\$3490
	<p>OPTIONAL CROSS HANDLE SOLD INDIVIDUALLY</p>	WE-HNDL-C	\$120
	<p>RISER EXTENSION KIT FOR WATERBRIDGE DECK FAUCETS</p> <p>ADJUSTABLE FROM 1/2" to 2-1/2" SOLD AS A PAIR</p>	WB-ACC-LEG-EXT	\$270





WATERBRIDGE TUB FILLERS

PHOTO	DESCRIPTION	PART NUMBER	LIST PRICE
	<p>WALL MOUNT LAV FAUCET WITH ELBOW SPOUT</p> <p>8" SPREAD, CENTER TO CENTER 10" REACH, WALL TO TIP 2" DROP, CENTER TO TIP</p>	WB-RTF-WM-LBO	\$2160
	<p>WALL MOUNT TUB FILLER WITH ELBOW SPOUT & HANDSHOWER</p> <p>8" SPREAD</p>	WB-RTF-WM-LBO-HS	\$5150
	<p>DECK MOUNT TUB FILLER WITH ELBOW SPOUT</p> <p>8" SPREAD, CENTER TO CENTER 6-1/4" SPOUT HEIGHT 6-1/2" CENTER TO AERATOR</p>	WB-RTF-DM-LBO	\$1890
	<p>FLOOR MOUNT TUB FILLER WITH ELBOW SPOUT</p> <p>8" SPREAD, CENTER TO CENTER 6-1/2" CENTER TO AERATOR 29-1/2" SPOUT HEIGHT</p> <p>SEE PAGE 43 FOR TUB DRAINS</p>	WB-RTF-FM-LBO	\$2490
	CUSTOM HEIGHT	WB-RTF-FM-LBO-CSTM	\$3490
	<p>FLOOR MOUNT TUB FILLER WITH ELBOW SPOUT & HANDSHOWER</p> <p>8" SPREAD, CENTER TO CENTER 8" CENTER TO SPOUT TIP 32" SPOUT HEIGHT</p> <p>SEE PAGE 43 FOR TUB DRAINS</p>	WB-RTF-FM-LBO-HS	\$5350
	CUSTOM HEIGHT	WB-RTF-FM-LBO-HS-CSTM	\$6350
	<p>OPTIONAL STABILIZER TEE FOR FLOOR-MOUNTED FAUCETS</p> <p>ATTACHES TO WALL, TUB, OR FLOOR 16" CENTER TO END CAN BE CUT TO LENGTH</p>	WB-ACC-TEE	\$575





WATERBRIDGE EXPOSED SHOWERS

PHOTO	DESCRIPTION	PART NUMBER	LIST PRICE
	<p>MODEL 840 WITH 8" RAINHEAD</p> <p>8" SPREAD, CENTER-TO-CENTER</p> <p>SEE PAGES 12-15 FOR MORE OPTIONS</p>	WB-SHW-840	\$4740
	<p>MODEL 850 WITH 8" RAINHEAD AND HANDSHOWER</p> <p>8" SPREAD, CENTER-TO-CENTER</p> <p>SEE PAGES 12-15 FOR MORE OPTIONS</p>	WB-SHW-850	\$5940
	<p>MODEL 870 WITH 8" RAINHEAD AND TUB FILLER</p> <p>8" SPREAD, CENTER-TO-CENTER</p> <p>SEE PAGES 12-15 FOR MORE OPTIONS</p>	WB-SHW-870	\$6140
	<p>MODEL 880 WITH 8" RAINHEAD, HANDSHOWER, AND TUB FILLER</p> <p>8" SPREAD, CENTER-TO-CENTER</p> <p>SEE PAGES 12-15 FOR MORE OPTIONS</p>	WB-SHW-880	\$7050





WATERBRIDGE EXPOSED SHOWERS

PHOTO	DESCRIPTION	PART NUMBER	LIST PRICE
	<p>MODEL 1040 WITH 8" RAINHEAD</p> <p>10" SPREAD, CENTER-TO-CENTER</p> <p>SEE PAGES 12-15 FOR MORE OPTIONS</p>	WB-SHW-1040	\$6400
	<p>MODEL 1050 WITH 8" RAINHEAD AND HANDSHOWER</p> <p>10" SPREAD, CENTER-TO-CENTER</p> <p>SEE PAGES 12-15 FOR MORE OPTIONS</p>	WB-SHW-1050	\$7610
	<p>MODEL 1070 8" RAINHEAD & FOOTWASH</p> <p>10" SPREAD, CENTER-TO-CENTER</p> <p>SEE PAGES 12-15 FOR MORE OPTIONS</p>	WB-SHW-1070	\$7810
	<p>MODEL 1080 8" RAINHEAD, HANDSHOWER, AND FOOTWASH</p> <p>10" SPREAD, CENTER-TO-CENTER</p> <p>SEE PAGES 12-15 FOR MORE OPTIONS</p>	WB-SHW-1080	\$8720

WATERBRIDGE EXPOSED SHOWERS

PHOTO	DESCRIPTION	PART NUMBER	LIST PRICE
	<p>MODEL 940 THERMOSTATIC SYSTEM WITH 8" RAINHEAD</p> <p>SEE PAGES 13-15 FOR MORE OPTIONS</p>	WB-SHW-940	\$6750
	<p>MODEL 950 THERMOSTATIC SYSTEM WITH 8" RAINHEAD AND HANDSHOWER</p> <p>SEE PAGES 13-15 FOR MORE OPTIONS</p>	WB-SHW-950	\$7960
	<p>MODEL 970 THERMOSTATIC SYSTEM WITH 8" RAINHEAD AND TUB FILLER</p> <p>SEE PAGES 13-15 FOR MORE OPTIONS</p>	WB-SHW-970	\$8160
	<p>MODEL 980 THERMOSTATIC SYSTEM WITH 8" RAINHEAD, HANDSHOWER, AND TUB FILLER</p> <p>SEE PAGES 13-15 FOR MORE OPTIONS</p>	WB-SHW-980	\$9060

WATERBRIDGE EXPOSED SHOWERS

PHOTO	DESCRIPTION	PART NUMBER	LIST PRICE
	<p>MODEL 1140 THERMOSTATIC SYSTEM WITH 8" RAINHEAD</p> <p>SEE PAGES 13-15 FOR MORE OPTIONS</p>	<p>WB-SHW-1140</p>	<p>\$8820</p>
	<p>MODEL 1150 THERMOSTATIC SYSTEM WITH 8" RAINHEAD AND HANDSHOWER</p> <p>SEE PAGES 13-15 FOR MORE OPTIONS</p>	<p>WB-SHW-1150</p>	<p>\$10,020</p>
	<p>MODEL 1170 THERMOSTATIC SYSTEM 8" RAINHEAD & FOOTWASH</p> <p>SEE PAGES 13-15 FOR MORE OPTIONS</p>	<p>WB-SHW-1170</p>	<p>\$10,220</p>
	<p>MODEL 1180 THERMOSTATIC SYSTEM 8" RAINHEAD, HANDSHOWER, AND FOOTWASH</p> <p>SEE PAGES 13-15 FOR MORE OPTIONS</p>	<p>WB-SHW-1180</p>	<p>\$11,130</p>

EXPOSED SHOWER OPTIONS



Build your custom shower with multiple options and configurations

DESCRIPTION	PART NUMBER	ADD-ON PRICE
GOOSENECK SHOWER ARM	WB-SHW-ARM-GN	\$2500
12" RAIN HEAD	SF-10-054	\$1100
CROSS HANDLES	WE-HNDL-C	\$120 (ea)
10" SPOUT EXTENSION	WB-SHW-FTWSH-1	\$260

CONTEMPORARY OPTIONS



Build your custom shower with multiple options and configurations

DESCRIPTION	PART NUMBER	ADD-ON PRICE
12" CONTEMPORARY HEAD	SF-10-047	\$1650
CONTEMPORARY HAND WAND	SF-10-010	\$280
EXTENDED FOOTWASH SPRAY	WB-SHW-FTWSH-2	\$360



EXPOSED SHOWER OPTIONS



Build your custom shower with multiple options and configurations

DESCRIPTION	PART NUMBER	ADD-ON PRICE
45° SHOWER ARM	WB-SHW-ARM45	\$270
PLUNGER SHOWER HEAD	SF-10-060	\$240
NEW 24" HANDSHOWER SLIDEBAR	HS-WM-SB	\$820
NEW LEFT-SIDE HANDSHOWER	WB-DIV-REV	\$600



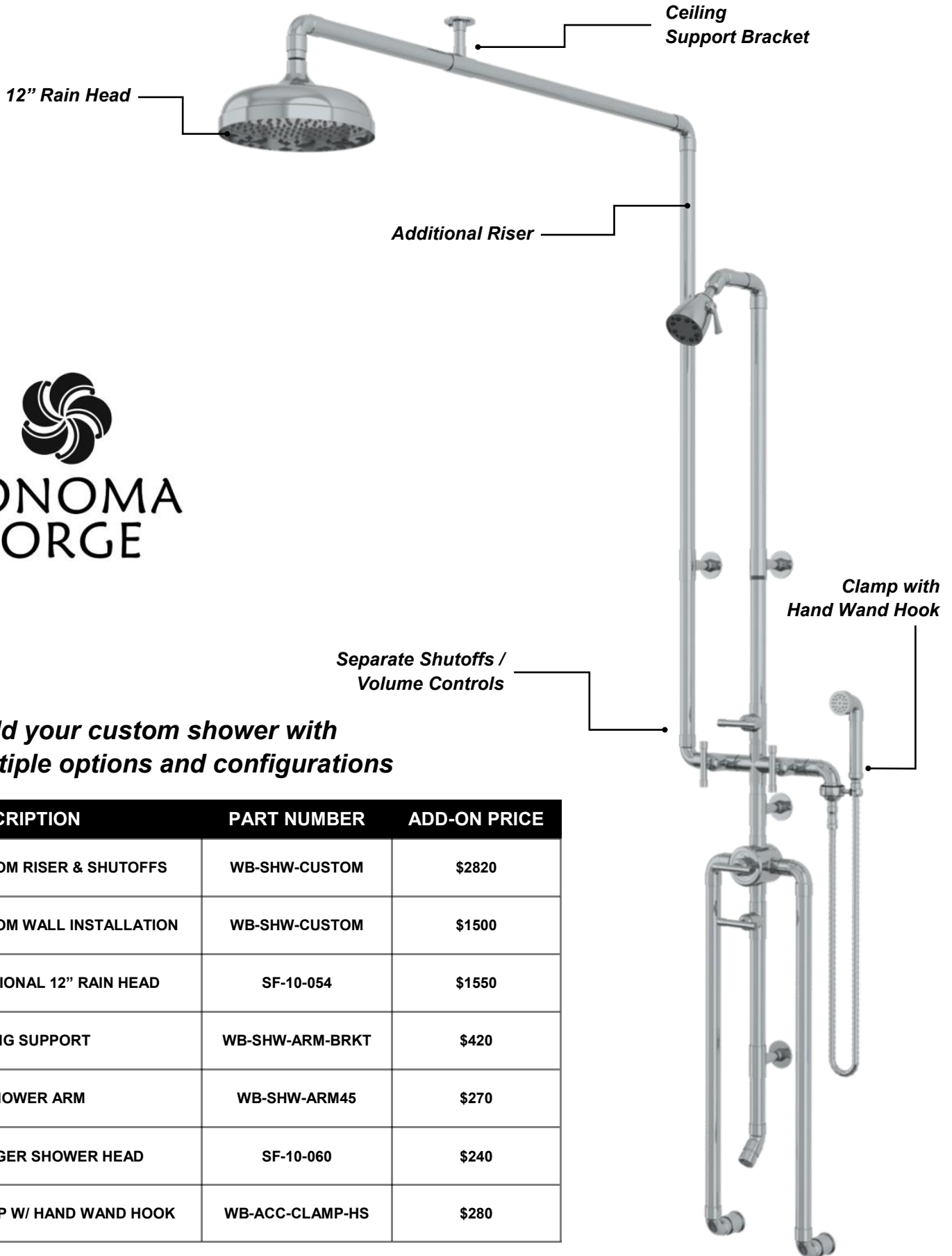

CUSTOM SYSTEMS



Build your custom shower with multiple options and configurations

DESCRIPTION	PART NUMBER	ADD-ON PRICE
CUSTOM RISER & SHUTOFFS	WB-SHW-CUSTOM	\$2820
CUSTOM WALL INSTALLATION	WB-SHW-CUSTOM	\$1500
ADDITIONAL 12" RAIN HEAD	SF-10-054	\$1550
CEILING SUPPORT	WB-SHW-ARM-BRKT	\$420
45° SHOWER ARM	WB-SHW-ARM45	\$270
PLUNGER SHOWER HEAD	SF-10-060	\$240
CLAMP W/ HAND WAND HOOK	WB-ACC-CLAMP-HS	\$280

WATERBRIDGE EXPOSED SHOWERS

PHOTO	DESCRIPTION	PART NUMBER	LIST PRICE
	<p>MODEL 140 COLD WATER SYSTEM WITH 8" RAINHEAD</p> <p>SEE PAGES 13-15 FOR MORE OPTIONS</p> <p>NEW</p>	<p>WB-SHW-140</p>	<p>\$3740</p>
	<p>MODEL 150 COLD WATER SYSTEM WITH 8" RAINHEAD AND HANDSHOWER</p> <p>SEE PAGES 13-15 FOR MORE OPTIONS</p> <p>NEW</p>	<p>WB-SHW-150</p>	<p>\$4940</p>
	<p>MODEL 170 COLD WATER SYSTEM WITH 8" RAINHEAD AND FOOTWASH</p> <p>SEE PAGES 13-15 FOR MORE OPTIONS</p> <p>NEW</p>	<p>WB-SHW-170</p>	<p>\$5140</p>
	<p>MODEL 180 COLD WATER SYSTEM WITH 8" RAINHEAD, HANDSHOWER, AND FOOTWASH</p> <p>SEE PAGES 13-15 FOR MORE OPTIONS</p> <p>NEW</p>	<p>WB-SHW-180</p>	<p>\$6050</p>







FOOT WASHES

PHOTO	DESCRIPTION	PART NUMBER	LIST PRICE
	<p>NEW</p> <p>WALL MOUNT FOOTWASH COLD WATER ONLY</p> <p>27" CENTER OF INLET TO SPOUT TIP</p>	WATERFALL WB-FTWSH-WM-WF	\$1870
		SPRAY WB-FTWSH-WM-SP	\$1870
	<p>NEW</p> <p>WALL MOUNT FOOTWASH WITH HANDSHOWER COLD WATER ONLY</p> <p>27" CENTER OF INLET TO SPOUT TIP</p>	WATERFALL WB-FTWSH-WM-WF-HS	\$2920
		SPRAY WB-FTWSH-WM-SP-HS	\$2920
	<p>NEW</p> <p>DECK MOUNT FOOTWASH COLD WATER ONLY</p>	WATERFALL WB-FTWSH-DM-WF	\$1870
		SPRAY WB-FTWSH-DM-SP	\$1870

EXPOSED SHOWER OPTIONS

PHOTO	DESCRIPTION	PART NUMBER	LIST PRICE
	45° SHOWER ARM 5" OVERALL LENGTH	WB-SHW-ARM45	\$530
	PLUNGER STYLE SHOWER HEAD	SF-10-060	\$690
	12" RAIN HEAD	SF-10-054	\$1550
	12" CONTEMPORARY RAIN HEAD	SF-10-047	\$2580
 NEW	CONTEMPORARY HAND WAND	SF-10-010	\$380
	10" EXTENSION * NOT RETROFITTABLE MUST BE ORDERED WITH SHOWER	WB-SHW-FTWSH-1	\$260
	EXTENDED FOOTWASH SPRAY REPLACES TUB SPOUT * NOT RETROFITTABLE MUST BE ORDERED WITH SHOWER	WB-SHW-FTWSH-2	\$360

EXPOSED SHOWER ACCESSORIES

PHOTO	DESCRIPTION	PART NUMBER	LIST PRICE	
	<p>HANDSHOWER SLIDEBAR WITH ADJUSTABLE CLAMP FOR HAND WAND</p> <p>NEW</p>	HS-WM-SB	\$820	
	<p>SHOWER DOOR HANDLES 9" ON CENTER - BACK TO BACK</p>	WB-SHW-HNDL	\$890	
	<p>CLAMP WITH HAND WAND HOOK ATTACHES TO TEES AND ELBOWS OF WATERBRIDGE FIXTURES</p>	WB-ACC-CLAMP-HS	\$280	
	<p>CLAMP WITH SOAP BASKET ATTACHES TO TEES AND ELBOWS OF WATERBRIDGE FIXTURES</p>	WB-ACC-CLAMP-SD	\$560	
	<p>CEILING OR WALL SUPPORT FOR WATERBRIDGE SHOWER ARMS</p> <p>* MUST BE ORDERED WITH SHOWER</p>	WB-SHW-ARM-BRKT	\$420	
	<p>GLASS BACKING DISCS ATTACHES TO SHOWER THROUGH GLASS</p>	WALL SUPPORT	WB-SHW-BKG	\$240
		WAND BRACKET	WB-HS-BKG	\$240
	<p>1/2" REMOTE THERMOSTATIC ANTI-SCALD MIXING VALVE</p>	SHW-WATTS	\$350	

ACCESSORIES

PHOTO	DESCRIPTION	PART NUMBER	LIST PRICE	
	ROBE HOOK	WB-ACC-RH	\$280	
	18" TOWEL BAR	WB-ACC-TB-18	\$500	
	24" TOWEL BAR	WB-ACC-TB-24	\$530	
	30" TOWEL BAR	WB-ACC-TB-30	\$560	
MEASURED IN OVERALL LENGTH				
	PAPER TOWEL HOLDER	WB-ACC-TB-11	\$500	
	TOWEL RING	WB-ACC-TWLR	\$480	
	WIRE BASKET SOAP DISH	WB-ACC-SD	\$430	
	TOILET PAPER HOLDER	WB-ACC-TP-1	\$500	
	TOILET PAPER HOLDER	WB-ACC-TP-2	\$500	
	MIRROR MOUNT (SOLD INDIVIDUALLY)	WB-ACC-MIR	\$150	
	BACKING DISCS	ROBE HOOK	WB-ACC-RH-BKG	\$240
	ATTACHES TO ACCESSORIES THROUGH GLASS	TOWEL BAR	WB-ACC-TB-BKG	\$240

ACCESSORIES

PHOTO	DESCRIPTION	PART NUMBER	LIST PRICE
	2" CABINET KNOB	WB-ACC-CP	\$60
	CABINET PULLS MEASURED IN OVERALL LENGTH	5" WB-ACC-CP5	\$160
		10" WB-ACC-CP10	\$200
	DECK-MOUNTED SOAP PUMP	WB-ACC-SP-DM	\$420
	COUNTERTOP SOAP PUMP INCLUDES BASE RING FOR STABILITY	WB-ACC-SP-CT	\$600
	WALL-MOUNTED SOAP PUMP INCLUDES WALL BRACKET	WB-ACC-SP-WM	\$600
	12" GRAB BAR	WB-ACC-GB12	\$470
	18" GRAB BAR	WB-ACC-GB18	\$500
	24" GRAB BAR	WB-ACC-GB24	\$530
	30" GRAB BAR	WB-ACC-GB30	\$560
	36" GRAB BAR	WB-ACC-GB36	\$590
	42" GRAB BAR	WB-ACC-GB42	\$620
	48" GRAB BAR	WB-ACC-GB48	\$650

MEASURED CENTER-TO-CENTER

WHEREVER COLLECTION

PHOTO	DESCRIPTION	PART NUMBER	LIST PRICE
	<p>WIDESPREAD DECK MOUNT LAV FAUCET WITH WATERFALL SPOUT</p> <p>7-1/4" CENTER TO TIP 3" SPOUT HEIGHT</p>	WE-LAV-DM-WF	\$2000
	TUB FILLER	WE-RTF-DM-WF	\$2500
	<p>SHORT DECK MOUNT LAV FAUCET WITH ELBOW SPOUT</p> <p>6" CENTER TO AERATOR 3-1/2" SPOUT HEIGHT</p>	WE-LAV-DM-LBO-S	\$2000
	TUB FILLER	WE-RTF-DM-LBO-S	\$2500
	<p>TALL DECK MOUNT LAV FAUCET WITH ELBOW SPOUT</p> <p>7-1/2" CENTER TO AERATOR 9" SPOUT HEIGHT</p>	WE-LAV-DM-LBO-T	\$2000
	TUB FILLER	WE-RTF-DM-LBO-T	\$2500
	<p>WIDESPREAD DECK MOUNT LAV FAUCET WITH FIXED GOOSENECK SPOUT</p> <p>6-1/2" CENTER TO AERATOR 3-1/2" SPOUT HEIGHT</p>	WE-LAV-DM-GN	\$2000
	TUB FILLER (8" PROJECTION)	NEW WE-RTF-DM-GN	\$2500
	<p>OPTIONAL CROSS HANDLE</p> <p>SOLD INDIVIDUALLY</p>	WE-HNDL-C	\$120

ALL FIXTURES INCLUDE ROUGH VALVES

WHEREVER COLLECTION

PHOTO	DESCRIPTION	PART NUMBER	LIST PRICE
	WALL MOUNT LAV FAUCET WITH WATERFALL SPOUT 7-3/4" WALL TO TIP 2-3/4" DROP, CENTER TO TIP	WE-LAV-WM-WF	\$2000
	TUB FILLER	WE-RTF-WM-WF	\$2500
	WALL MOUNT LAV FAUCET WITH ELBOW SPOUT 5-3/4" WALL TO AERATOR 2-1/8" DROP, CENTER TO TIP	WE-LAV-WM-LBO-S	\$2000
	TUB FILLER	WE-RTF-WM-LBO-S	\$2500
	WALL MOUNT LAV FAUCET WITH ELBOW SPOUT 8-1/2" WALL TO AERATOR 2-1/8" DROP, CENTER TO TIP	WE-LAV-WM-LBO-L	\$2000
	TUB FILLER	WE-RTF-WM-LBO-L	\$2500
	WALL MOUNT LAV FAUCET 6-3/4" WALL TO AERATOR 3" DROP, CENTER TO TIP	WE-LAV-WM-7	\$2000
	TUB FILLER	WE-RTF-WM-7	\$2500
	WALL MOUNT LAV FAUCET 8-3/4" WALL TO AERATOR 3" DROP, CENTER TO TIP	WE-LAV-WM-9	\$2000
	TUB FILLER	WE-RTF-WM-9	\$2500
	OPTIONAL CROSS HANDLE SOLD INDIVIDUALLY	WE-HNDL-C	\$120







ALL FIXTURES INCLUDE ROUGH VALVES

WHEREVER COLLECTION







PHOTO	DESCRIPTION		PART NUMBER	LIST PRICE
	PRESSURE BALANCE CONTROL W/7" TRIM PLATE	1/2"	WE-PB	\$1970
	THERMOSTATIC CONTROL W/7" TRIM PLATE	3/4"	WE-THERM	\$2340
	SHUTOFF / VOLUME CONTROL	1/2"	WE-WM-1/2VC	\$880
		3/4"	WE-WM-3/4VC	
	1/2" DIVERTER	1 IN, 2 OUT	WE-WM-DIV2	\$880
		1 IN, 2 OUT W/SHUTOFF	WE-WM-DIV2-SO	
		1 IN, 2 OUT DECK MOUNTED	WE-DM-DIV2	
		1 IN, 3 OUT	WE-WM-DIV3	
		1 IN, 3 OUT W/SHUTOFF	WE-WM-DIV3-SO	
	WALL MOUNTED WATERFALL TUB SPOUT 7-3/4" WALL TO SPOUT TIP 2-3/4" DROP, CENTER TO TIP		WE-RTF-WM-WF-SPT	\$1325
	WALL MOUNTED 7" TUB SPOUT 6-3/4" LONG, WALL TO CENTER 3" DROP, CENTER TO TIP		WE-RTF-WM-7-SPT	\$1325
	WALL MOUNTED SHORT ELBOW TUB SPOUT 5-3/4" WALL TO AERATOR 2-1/8" DROP, CENTER TO TIP		WE-RTF-WM-LBO-S-SPT	\$1325
	1/2" REMOTE THERMOSTATIC ANTI-SCALD MIXING VALVE		SHW-WATTS	\$350

ALL CONTROLS INCLUDE ROUGH VALVES

WHEREVER COLLECTION

PHOTO	DESCRIPTION	PART NUMBER	LIST PRICE	
	LARGE 8-PLUNGER SHOWER HEAD WITH 1/2" x 8" ARM AND WALL FLANGE 3-1/2" DIAMETER FACE ADJUSTABLE SPRAY	SF-10-105	\$940	
	8" SWIVELING RAINHEAD WITH RUBBER JETS 1/2" FIP	SF-10-052	\$900	
	12" SWIVELING RAINHEAD WITH RUBBER JETS 1/2" FIP	SF-10-054	\$1550	
	FLANGE FOR 1/2" ARMS AND NECKS	SF-10-102	\$80	
		1/2" x 4"	SF-10-154	\$160
	CEILING MOUNT SHOWER NECKS	1/2" x 8"	SF-10-140	\$180
		1/2" x 18"	SF-10-146	\$280
	L-SHAPED SHOWER ARMS	1/2" x 12" x 4"	SF-10-141	\$220
		1/2" x 19" x 4"	SF-10-142	\$270
	1/2" S-SHAPED SHOWER ARM RAISES HEAD APPROX. 10" FROM INLET	SF-10-147	\$190	

WHEREVER COLLECTION

PHOTO	DESCRIPTION	PART NUMBER	LIST PRICE
	WATERBRIDGE SHOWER ARM 3/4" NPT, 1/2" NPS	12"	WB-SHW-ARM12 \$520
		18"	WB-SHW-ARM18 \$530
	WATERBRIDGE 45° SHOWER ARM 5" OVERALL LENGTH 3/4" NPT, 1/2" NPS	WB-SHW-ARM45	\$540
	SHOWER ARM TRIM RING FOR USE WITH ABOVE SHOWER ARMS AND CONCEALED SHOWER SYSTEMS	WE-TRIM-RING	\$60
	SHOWER DOOR HANDLES 9" ON CENTER - BACK TO BACK	WB-SHW-HNDL	\$890
	WALL MOUNT SOAP DISH	WB-ACC-SD	\$425
	BODY SPRAY 1/2" FIP	SF-10-063	\$320

HANDSHOWER KITS

PHOTO	DESCRIPTION	PART NUMBER	LIST PRICE
	DECK-MOUNTED HAND SHOWER KIT	WB-10-276	\$1020
	WALL-MOUNTED HAND SHOWER KIT	WB-10-255	\$1080
	WALL-MOUNTED HAND SHOWER KIT WITH 24" SLIDEBAR	WB-10-272	\$1850
	WATERBRIDGE HAND SHOWER SEPARATE HOT & COLD HANDLES	WB-HS-WM-HC	\$2490
	WATERBRIDGE HAND SHOWER THERMOSTATIC TEMPERATURE CONTROL	WB-HS-WM-THERM	\$4490
	FINISHED 60" REPLACEMENT HOSE FOR WALL-MOUNTED HAND SHOWERS	SF-10-015	\$220

NEW

NEW

NEW

SEE PAGE 32 FOR CONTEMPORARY HANDSHOWER KITS

CIXX COLLECTION



AVAILABLE WHILE SUPPLIES LAST

PHOTO	DESCRIPTION	PART NUMBER	LIST PRICE
	DECK MOUNT SHORT LAV FAUCET 4-7/8" CENTER TO AERATOR 3" SPOUT HEIGHT	CX-LAV-DM-S	\$1850
	DECK MOUNT TALL LAV FAUCET 6-3/4" CENTER TO AERATOR 2-1/2" SPOUT HEIGHT	CX-LAV-DM-T	\$1950
	WALL MOUNT LAV FAUCET 7-1/2" WALL TO AERATOR 1-3/4" CENTER TO TIP	CX-LAV-WM	\$1850
	CABINET KNOB 1-1/2" SQUARE	CX-ACC-CP	\$80
	TOILET PAPER HOLDER 10" OVERALL, SINGLE POST	CX-ACC-TP	\$430
 MEASURED INSIDE MOUNTING BRACKETS	18"	CX-ACC-TB-18	\$475
	24"	CX-ACC-TB-24	\$500
	30"	CX-ACC-TB-30	\$525

ALL FIXTURES INCLUDE ROUGH VALVES



CIXX COLLECTION

AVAILABLE WHILE SUPPLIES LAST



PHOTO	DESCRIPTION	PART NUMBER	LIST PRICE	
	SHOWER ARM & HEAD *AVAILABLE ONLY IN HAMMERED STEEL	CX-SHW-HD	\$1850	
	THERMOSTATIC CONTROL W/6" TRIM PLATE	3/4"	CX-THERM	\$2200
	PRESSURE BALANCE CONTROL W/6" TRIM PLATE	1/2"	CX-PB	\$1980
	SHUTOFF / VOLUME CONTROL	1/2"	CX-WM-1/2VC	\$900
		3/4" VALVE	CX-WM-3/4VC	
	1/2" DIVERTER	1 IN, 2 OUT	CX-WM-DIV2	\$900
		1 IN, 2 OUT W/SHUTOFF	CX-WM-DIV2-SO	
		1 IN, 3 OUT	CX-WM-DIV3	
		1 IN, 3 OUT W/SHUTOFF	CX-WM-DIV3-SO	
1/2" DECK DIVERTER	1 IN, 2 OUT	CX-DM-DIV		

ALL CONTROLS INCLUDE ROUGH VALVES

STRAP COLLECTION

PHOTO	DESCRIPTION	PART NUMBER	LIST PRICE
	WIDESPREAD DECK MOUNT LAV FAUCET 7" CENTER TO AERATOR 3-1/2" SPOUT HEIGHT	ST-LAV-DM	\$1340
	TUB FILLER	ST-RTF-DM	\$1700
	WIDESPREAD WALL MOUNT LAV FAUCET 8-3/8" WALL TO AERATOR	ST-LAV-WM-L	\$1340
	TUB FILLER	ST-RTF-WM-L	\$1700
	WIDESPREAD WALL MOUNT LAV FAUCET 5-3/4" WALL TO AERATOR	ST-LAV-WM-S	\$1340
	TUB FILLER	ST-RTF-WM-S	\$1700



ACCESSORIES

	ROBE HOOK	ST-ACC-RH	\$260
	TOILET PAPER HOLDER	ST-ACC-TP	\$400
		18" ST-ACC-TB18	\$460
		24" ST-ACC-TB24	\$480
		30" ST-ACC-TB30	\$500

MEASURED BETWEEN ESCUTCHEONS







ALL FIXTURES INCLUDE ROUGH VALVES

STRAP CONCEALED SHOWERS





PHOTO	DESCRIPTION		PART NUMBER	LIST PRICE
	PRESSURE BALANCE CONTROL	1/2" VALVE 6-3/4" PLATE	ST-PB	\$1830
	THERMOSTATIC CONTROL	3/4" VALVE 6-3/4" PLATE	ST-THERM	\$2340
	SHUTOFF / VOLUME CONTROL	1/2"	ST-WM-1/2VC	\$480
		3/4"	ST-WM-3/4VC	
	1/2" DIVERTER	1 IN, 2 OUT	ST-WM-DIV2	\$480
		1 IN, 2 OUT W/POSITIVE SHUTOFF	ST-WM-DIV2-SO	
		1 IN, 3 OUT	ST-WM-DIV3	
		1 IN, 3 OUT W/POSITIVE SHUTOFF	ST-WM-DIV3-SO	
1/2" DECK DIVERTER	1 IN, 2 OUT	ST-DM-DIV		

ALL CONTROLS INCLUDE ROUGH VALVES







STRAP / CONTEMPORARY SHOWER OPTIONS

PHOTO	DESCRIPTION	PART NUMBER	LIST PRICE
	8-PLUNGER SHOWER HEAD WITH 1/2" x 8" ARM AND SQUARE WALL FLANGE 3-1/2" DIAMETER FACE ADJUSTABLE SPRAY	ST-10-105	\$940
	ROUND SWIVELING RAIN HEAD WITH RUBBER JETS 7"	SF-10-042	\$840
	1/2" FIP 12"	SF-10-047	\$2100
	SQUARE SWIVELING RAIN HEAD WITH RUBBER JETS 6" x 7"	SF-10-037	\$960
	1/2" FIP 12"	SF-10-088	\$2300
	ROUND BODY SPRAY WITH SQUARE FLANGE 1/2" FIP	ST-10-124	\$380
	WALL-MOUNTED HAND SHOWER KIT WITH CONTEMPORARY HAND WAND	ST-10-135	\$1350
	WALL-MOUNTED HAND SHOWER KIT WITH CONTEMPORARY HAND WAND AND 24" SLIDEBAR	ST-18-132	\$2100
	DECK-MOUNTED HAND SHOWER KIT WITH CONTEMPORARY HAND WAND AND 59" CHROME HOSE	ST-10-361	\$1300

STRAP / CONTEMPORARY SHOWER OPTIONS







PHOTO	DESCRIPTION		PART NUMBER	LIST PRICE
	SQUARE FLANGE FOR 1/2" ARMS AND NECKS	FOR 1/2" ARMS	SF-10-049	\$150
	ROUND FLANGE FOR ARMS AND NECKS	FOR 1/2" ARMS	SF-10-102	\$140
	CEILING MOUNT SHOWER NECKS	1/2" x 4"	SF-10-154	\$160
		1/2" x 8"	SF-10-140	\$180
		1/2" x 18"	SF-10-146	\$280
	L-SHAPED SHOWER ARMS	1/2" x 12" x 4"	SF-10-141	\$220
		1/2" x 19" x 4"	SF-10-142	\$270
	1/2" S-SHAPED SHOWER ARM RAISES HEAD APPROX. 10" FROM INLET		SF-10-147	\$190

SANS HANDS

PHOTO	DESCRIPTION	PART NUMBER	LIST PRICE
	SANS HANDS WITH WHEREVER DECK MOUNT WATERFALL SPOUT 7-1/4" CENTER TO TIP 3" SPOUT HEIGHT	SANS-WE-DM-WF	\$1900
	SANS HANDS WITH WHEREVER DECK MOUNT GOOSENECK SPOUT 6-1/2" CENTER TO AERATOR 3-1/2" SPOUT HEIGHT	SANS-WE-DM-GN	\$1900
	SANS HANDS WITH WHEREVER SHORT DECK MOUNT ELBOW SPOUT 6" PROJECTION, CENTER TO AERATOR 3-1/2" SPOUT HEIGHT	SANS-WE-DM-LBO-S	\$1900
	SANS HANDS WITH WHEREVER TALL DECK MOUNT ELBOW SPOUT 7-1/2" PROJECTION, CENTER TO AERATOR 9" SPOUT HEIGHT	SANS-WE-DM-LBO-T	\$1900
	SANS HANDS WITH STRAP DECK MOUNT SPOUT 7" PROJECTION, CENTER TO AERATOR 3-1/2" SPOUT HEIGHT	SANS-ST-DM	\$1900
	OPTIONAL AC ADAPTER / TRANSFORMER *AVAILABLE FOR A LIMITED TIME	SANS-AC-ADAPTER	\$50





ALL FAUCETS INCLUDE VALVES & BATTERY PACK

SANS HANDS

PHOTO	DESCRIPTION	PART NUMBER	LIST PRICE
	SANS HANDS WITH WHEREVER WALL MOUNT WATERFALL SPOUT 7-3/4" WALL TO TIP 2-3/4" DROP, CENTER TO TIP	SANS-WE-WM-WF	\$1900
	SANS HANDS WITH WHEREVER WALL MOUNT SPOUT 6-3/4" WALL TO AERATOR 3" DROP, WALL TO TIP	SANS-WE-WM-7	\$1900
	SANS HANDS WITH WHEREVER WALL MOUNT SPOUT 8-3/4" WALL TO AERATOR 3" DROP, WALL TO TIP	SANS-WE-WM-9	\$1900
	SANS HANDS WITH WHEREVER WALL MOUNT SHORT ELBOW SPOUT 5-3/4" WALL TO AERATOR 2-1/8" DROP, CENTER TO AERATOR	SANS-WE-WM-LBO-S	\$1900
	SANS HANDS WITH WHEREVER WALL MOUNT LONG ELBOW SPOUT 8-1/2" LONG, WALL TO AERATOR 2-1/8" DROP, CENTER TO AERATOR	SANS-WE-WM-LBO-L	\$1900
	SANS HANDS WITH STRAP WALL MOUNT SPOUT 8-1/2" WALL TO AERATOR	SANS-ST-WM	\$1900
	OPTIONAL AC ADAPTER / TRANSFORMER *AVAILABLE FOR A LIMITED TIME	SANS-AC-ADAPTER	\$50

ALL FAUCETS INCLUDE VALVES & BATTERY PACK

BRUT COLLECTION

PHOTO	DESCRIPTION	PART NUMBER	LIST PRICE
	BRUT SHORT LAV FAUCET WITH FIXED ELBOW SPOUT 6-1/2" CENTER TO AERATOR 4" SPOUT HEIGHT	BRUT-LBO-S-FX	\$1870
	BRUT TALL LAV FAUCET WITH FIXED ELBOW SPOUT 7-1/2" CENTER TO AERATOR 8" SPOUT HEIGHT	BRUT-LBO-T-FX	\$1870
	BRUT SHORT LAV FAUCET WITH FIXED WATERFALL SPOUT 7" CENTER TO TIP 2-1/2" SPOUT HEIGHT	BRUT-WF-S-FX	\$1870
	BRUT TALL LAV FAUCET WITH FIXED WATERFALL SPOUT 7" CENTER TO TIP 7-1/2" SPOUT HEIGHT	BRUT-WF-T-FX	\$1870
	BRUT FAUCET WITH SWIVEL ELBOW SPOUT 8-3/4" CENTER TO AERATOR 8-3/4" SPOUT HEIGHT	BRUT-LBO-SW	\$1980
	FAUCET WITH SIDE SPRAY	BRUT-LBO-W/SP	\$2180

BRUT COLLECTION



DESCRIPTION	PART NUMBER	LIST PRICE
BRUT FAUCET WITH SWIVEL SPOUT AND PULL-OUT SPRAYER 9-3/4" CENTER-TO-AERATOR 11-1/2" SPOUT HEIGHT	BRUT-PO	\$2230



DESCRIPTION	PART NUMBER	LIST PRICE
BRUT FAUCET WITH SWIVEL ELBOW SPOUT 7-1/2" CENTER-TO-AERATOR 8-1/2" SPOUT HEIGHT	BRUT-PREP	\$2030

WATERBRIDGE KITCHEN & BAR





PHOTO	DESCRIPTION	PART NUMBER	LIST PRICE
	<p>WATERBRIDGE DECK FAUCET WITH GOOSENECK SPOUT</p> <p>8" SPREAD, CENTER TO CENTER 6-1/2" CENTER TO AERATOR</p>	FIXED SPOUT	WB-DM-GN-FX \$2060
		SWIVEL SPOUT	WB-DM-GN-SW \$2260
	<p>WATERBRIDGE WALL FAUCET WITH GOOSENECK SPOUT</p> <p>8" SPREAD, CENTER TO CENTER 6-1/2" CENTER TO AERATOR</p>	FIXED SPOUT	WB-WM-GN-FX \$2110
		SWIVEL SPOUT	WB-WM-GN-SW \$2260
	<p>WATERBRIDGE DECK FAUCET WITH LARGE SWIVEL GOOSENECK SPOUT</p> <p>8" SPREAD, CENTER TO CENTER 11" CENTER TO AERATOR</p>	SWIVEL SPOUT	WB-DM-GN-LG \$2450
	<p>WATERBRIDGE WALL FAUCET WITH LARGE GOOSENECK SPOUT</p> <p>8" SPREAD, CENTER TO CENTER 11" CENTER TO AERATOR</p>	SWIVEL SPOUT	WB-WM-GN-LG \$2450
	<p>WATERBRIDGE DECK MOUNT FAUCET WITH SQUARE SPOUT</p> <p>8" SPREAD, CENTER TO CENTER 9-1/2" CENTER TO AERATOR</p>	FIXED SPOUT	WB-DM-SQ-FX \$2060
		SWIVEL SPOUT	WB-DM-SQ-SW \$2260
	<p>WATERBRIDGE WALL FAUCET WITH SQUARE SPOUT</p> <p>8" SPREAD, CENTER TO CENTER 9-1/2" SPOUT, CENTER TO AERATOR</p>	FIXED SPOUT	WB-WM-SQ-FX \$2110
		SWIVEL SPOUT	WB-WM-SQ-SW \$2260

CUVEE AND WINGNUT KITCHEN & BAR

PHOTO	DESCRIPTION		PART NUMBER	LIST PRICE
	CUVÉE DECK MOUNT FAUCET WITH GOOSENECK SPOUT	FIXED SPOUT	CV-GN-FX	\$1450
	6-1/2" CENTER TO AERATOR 8-1/2" SPOUT HEIGHT	SWIVEL SPOUT	CV-GN-SW	\$1600
	FAUCET WITH SIDE SPRAY	SWIVEL SPOUT	CV-GN-W/SP	\$1860
	CUVÉE DECK MOUNT FAUCET WITH LARGE GOOSENECK SPOUT	SWIVEL SPOUT	CV-GN-LG	\$1600
	11" CENTER TO AERATOR 8-1/2" SPOUT HEIGHT			
	FAUCET WITH SIDE SPRAY	SWIVEL SPOUT	CV-GN-LG-W/SP	\$1960
	WINGNUT DECK MOUNT FAUCET WITH GOOSENECK SPOUT	FIXED SPOUT	WN-GN-FX	\$1450
	6-1/2" CENTER TO AERATOR 8-1/2" SPOUT HEIGHT	SWIVEL SPOUT	WN-GN-SW	\$1600
	FAUCET WITH SIDE SPRAY	SWIVEL SPOUT	WN-GN-W/SP	\$1860
	WINGNUT DECK MOUNT FAUCET WITH LARGE GOOSENECK SPOUT	SWIVEL SPOUT	WN-GN-LG	\$1700
	11" CENTER TO AERATOR 8-1/2" SPOUT HEIGHT			
	FAUCET WITH SIDE SPRAY	SWIVEL SPOUT	WN-GN-LG-W/SP	\$1960
	WINGNUT DECK MOUNT FAUCET WITH SQUARE SPOUT	FIXED SPOUT	WN-SQ-FX	\$1450
	9-1/2" CENTER TO AERATOR 6" SPOUT HEIGHT	SWIVEL SPOUT	WN-SQ-SW	\$1600
	FAUCET WITH SIDE SPRAY	SWIVEL SPOUT	WN-SQ-W/SP	\$1860
	WINGNUT SIDE SPRAY		WN-SP	\$420

BROWNSTONE COLLECTION

AVAILABLE FOR A LIMITED TIME

PHOTO	DESCRIPTION	PART NUMBER	LIST PRICE
	<p>DECK FAUCET CERAMIC HOT & COLD BUTTONS</p> <p>6-1/2" CENTER TO AERATOR 9-5/8" HEIGHT, TO SPOUT TIP</p>	FIXED SPOUT BS-DM-FX	\$1500
		SWIVEL SPOUT BS-DM-SW	\$1700
	<p>DECK FAUCET WITH SWIVEL SPOUT AND SIDE SPRAY CERAMIC HOT & COLD BUTTONS</p> <p>6-1/2" CENTER TO AERATOR 9-5/8" HEIGHT, TO SPOUT TIP</p>	BS-DM-SW-W/SP	\$2200
	<p>DECK FAUCET WITH LARGE SWIVEL SPOUT CERAMIC HOT & COLD BUTTONS</p> <p>11" CENTER TO AERATOR 9" HEIGHT, TO SPOUT TIP</p>	BS-DM-LG	\$1950
	<p>DECK FAUCET WITH LARGE SWIVEL SPOUT AND SIDE SPRAY CERAMIC HOT & COLD BUTTONS</p> <p>11" CENTER TO AERATOR 9" HEIGHT, TO SPOUT TIP</p>	BS-DM-LG-W/SP	\$2350

POINT OF USE FAUCETS







PHOTO	DESCRIPTION		PART NUMBER	LIST PRICE
	POINT OF USE FAUCET WITH ELBOW SPOUT	HOT & COLD	POU-LBO-HC	\$975
	POINT OF USE FAUCET WITH ELBOW SPOUT	COLD ONLY (HANDLE ON RIGHT)	POU-LBO-C	\$725
		HOT ONLY (HANDLE ON LEFT)	POU-LBO-H	\$750
	POINT OF USE FAUCET WITH GOOSENECK SPOUT		POU-GN-HC	\$875
	POINT OF USE FAUCET WITH GOOSENECK SPOUT	COLD ONLY (HANDLE ON RIGHT)	POU-GN-C	\$625
		HOT ONLY (HANDLE ON LEFT)	POU-GN-H	\$650

NOT COMPATIBLE WITH REVERSE OSMOSIS SYSTEMS

KITCHEN & BAR

PHOTO	DESCRIPTION	PART NUMBER	LIST PRICE	
		STANDARD SINKS WITHOUT DISPOSAL	SF-11-252	\$140
	KITCHEN DRAINS WITH STRAINERS FITS 3-1/2" - 4" OPENINGS	STANDARD SINKS WITH ISE-TYPE DISPOSAL	SF-11-361	\$180
		THICK SINKS WITHOUT DISPOSAL	SF-11-300	\$220
		THICK SINKS WITH ISE-TYPE DISPOSAL	SF-11-362	\$260
	BAR SINK DRAIN WITH STRAINER FITS 2" OPENINGS 1-1/2" DRAIN, 2-7/8" FACE DIAMETER NO OVERFLOW	DRAIN-BAR	\$140	
	AIR GAP KIT	SF-37-001	\$120	
	AIR SWITCH AND CONTROLLER	SF-37-018	\$480	
	AIR SWITCH BUTTON ONLY	SF-37-017	\$260	









LAV & TUB DRAINS

PHOTO	DESCRIPTION		PART NUMBER	LIST PRICE
	<p>FLIP-TOP DRAIN</p> <p>1-1/4" DRAIN, 2-3/8" FACE DIAMETER WITHOUT OVERFLOW</p> <p>AVAILABLE WITH OVERFLOW BY SPECIAL ORDER</p>	LAV	DRAIN-FT	\$220
	<p>SOFT TOUCH DRAIN</p> <p>WITHOUT OVERFLOW</p> <p>AVAILABLE WITH OVERFLOW BY SPECIAL ORDER</p>	LAV	DRAIN-ST	\$220
	<p>GRID DRAIN</p> <p>WITHOUT OVERFLOW</p> <p>AVAILABLE WITH OVERFLOW BY SPECIAL ORDER</p>	LAV	DRAIN-GR	\$220
	<p>1-1/4" x 12" P-TRAP WITH FLANGE</p>	TUB	DRAIN-TRAP	\$260
	<p>1-1/4" x 8" DRAIN EXTENSION</p>		DRAIN-EXT	\$180
	<p>1-1/4" x 12" EXTENDED TAILPIECE</p> <p>*FITS ONLY FLIP-TOP AND GRID DRAINS</p>		DRAIN-TAIL	\$140
	<p>REMOTE TUB WASTE AND OVERFLOW</p> <p>INCLUDES GERBER-STYLE GRID DRAIN</p> <p>CONTACT US FOR SPECIAL-ORDER FINISHES</p>		WB-RTDO	\$2990

FLOOR DRAINS

PHOTO	DESCRIPTION	PART NUMBER	LIST PRICE
	2" ABS FLOOR DRAIN ROUGH FOR 4" TOPS	SF-2ABS	\$160
	2" PVC FLOOR DRAIN ROUGH FOR 4" TOPS	SF-2PVC	\$160
	3" ABS FLOOR DRAIN ROUGH FOR 5" & 6" TOPS	SF-3ABS	\$180
	3" PVC FLOOR DRAIN ROUGH FOR 5" & 6" TOPS	SF-3PVC	\$180
	2" CAST IRON FLOOR DRAIN ROUGH FOR 5" & 6" TOPS	SF-2CI	\$220
	4" SQUARE DRAIN TOP	SF-4SQ	\$380
	5" SQUARE DRAIN TOP	SF-5SQ	\$440
	6" SQUARE DRAIN TOP	SF-6SQ	\$480
	4" ROUND DRAIN TOP	SF-4RND	\$560
	6" ROUND DRAIN TOP	SF-6RND	\$580

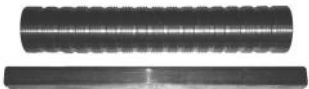
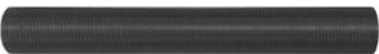
MISCELLANEOUS / REPLACEMENT PARTS

PHOTO	DESCRIPTION	PART NUMBER	LIST PRICE
	SET OF STANDARD FINISH SAMPLES	FINISH SAMPLES	\$50
	20-POINT 1/2" CARTRIDGE FOR: WATERBRIDGE, WHEREVER, CIXX, AND BROWNSTONE FAUCETS	1/2-CART-20-H	\$40
		1/2-CART-20-C	\$40
	16-POINT 1/2" CARTRIDGE FOR: WINGNUT, CUVEE, AND STRAP FAUCETS	1/2-CART-16-H	\$40
		1/2-CART-16-C	\$40
	3/4" CARTRIDGE	3/4-CART-20-H	\$50
		3/4-CART-20-C	\$50
	1" STEM EXTENSION FOR WHEREVER & CIXX CONTROLS	STEM-EXT-1	\$40
	1-1/2" STEM EXTENSION KIT FOR WHEREVER & CIXX CONTROLS INCLUDES THREADED TUBE AND VALVE STEM EXTENSIONS, WITH .02 oz. TUBE OF ADHESIVE	STEM-EXT-1-1/2	\$85
	1-3/4" STEM EXTENSION KIT FOR STRAP CONTROLS INCLUDES THREADED TUBE AND VALVE STEM EXTENSIONS, WITH .02 oz. TUBE OF ADHESIVE	STEM-EXT-1-3/4	\$45
	THERMOSTATIC VALVE STEM EXTENSION REPLACEMENT 4-1/2" THREADED TUBE AND 5" INNER SQUARE TUBE	THERM-TUBE-EXT	\$130
	3/4" x 12" STRAIGHT NIPPLE	NIPPLE-3/4-12	\$65
	PACK OF FOUR 3" WOOD SCREWS WITH FINISHED HEADS	WB-SCREWS	\$35

INDEX

PART NUMBER	PAGE	PART NUMBER	PAGE	PART NUMBER	PAGE	PART NUMBER	PAGE
1/2-CART	45	SANS-WE-WM-7	35	THERM-TUBE-EXT	45	WB-SHW-1080	9
3/4-CART	45	SANS-WE-WM-9	35	WB-10-255	27	WB-SHW-1140	11
BRUT-LBO-S-FX	36	SANS-WE-WM-LBO-L	35	WB-10-272	27	WB-SHW-1150	11
BRUT-LBO-SW	36	SANS-WE-WM-LBO-S	35	WB-10-276	27	WB-SHW-1170	11
BRUT-LBO-T-FX	36	SANS-WE-WM-WF	35	WB-ACC-CLAMP-HS	19	WB-SHW-1180	11
BRUT-LBO-W/SP	36	SF-10-010	18	WB-ACC-CLAMP-SD	19	WB-SHW-840	8
BRUT-PO	37	SF-10-015	24	WB-ACC-CP	21	WB-SHW-850	8
BRUT-PREP	37	SF-10-037	32	WB-ACC-CP5	21	WB-SHW-870	8
BRUT-WF-S-FX	36	SF-10-042	32	WB-ACC-CP10	21	WB-SHW-880	8
BRUT-WF-T-FX	36	SF-10-047	32	WB-ACC-GB	21	WB-SHW-940	10
BS-DM-FX	40	SF-10-049	33	WB-ACC-LEG EXT	4	WB-SHW-950	10
BS-DM-LG	40	SF-10-052	25	WB-ACC-MIR	20	WB-SHW-970	10
BS-DM-LG-W/SP	40	SF-10-054	25	WB-ACC-RH	20	WB-SHW-980	10
BS-DM-SW	40	SF-10-060	18	WB-ACC-RH-BKG	20	WB-SHW-ARM12	26
BS-DM-SW-W/SP	40	SF-10-063	26	WB-ACC-SD	20	WB-SHW-ARM18	12
CV-GN-FX	39	SF-10-088	32	WB-ACC-SP-CT	21	WB-SHW-ARM45	14 & 26
CV-GN-LG	39	SF-10-102	25	WB-ACC-SP-DM	21	WB-SHW-ARM-BRKT	15 & 19
CV-GN-LG-W/SP	39	SF-10-105	25	WB-ACC-SP-WM	21	WB-SHW-BKG	19
CV-GN-SW	39	SF-10-140	25	WB-ACC-TB	20	WB-SHW-FTWSH-1	12 & 18
CV-GN-W/SP	39	SF-10-141	25	WB-ACC-TB-BKG	20	WB-SHW-FTWSH-2	13 & 18
CX-ACC-CP	28	SF-10-142	25	WB-ACC-TEE	7	WB-SHW-HNDL	19
CX-ACC-RH	28	SF-10-154	25	WB-ACC-TP-1	20	WB-WM-GN-FX	38
CX-ACC-TB	28	SF-10-156	25	WB-ACC-TP-2	20	WB-WM-GN-LG	38
CX-ACC-TP	28	SF-11-252	42	WB-ACC-TWLR	20	WB-WM-GN-SW	38
CX-DM-DIV	29	SF-11-257	43	WB-DM-GN-FX	38	WB-WM-SQ-FX	38
CX-LAV-DM-S	28	SF-11-269	43	WB-DM-GN-LG	38	WB-WM-SQ-SW	38
CX-LAV-DM-T	28	SF-11-300	42	WB-DM-GN-SW	38	WE-DM-DIV2	24
CX-LAV-WM	28	SF-11-361	42	WB-DM-SQ-FX	38	WE-HNDL-C	4, 6, 22
CX-PB	29	SF-11-362	42	WB-DM-SQ-SW	38	WE-LAV-DM-GN	22
CX-RTF-DM	28	SF-2ABS	44	WB-FTWSH-DM-SP	17	WE-LAV-DM-LBO-S	22
CX-RTF-WM	28	SF-2PVC	44	WB-FTWSH-DM-WF	17	WE-LAV-DM-LBO-T	22
CX-RTF-WM-SPOUT	29	SF-37-001	42	WB-FTWSH-WM-SP	17	WE-LAV-DM-WF	22
CX-SHW-HD	29	SF-37-017	42	WB-FTWSH-WM-SP-HS	17	WE-LAV-WM-7	23
CX-SHW-HNDL	29	SF-37-018	42	WB-FTWSH-WM-WF	17	WE-LAV-WM-9	23
CX-THERM	29	SF-3ABS	44	WB-FTWSH-WM-WF-HS	17	WE-LAV-WM-LBO-L	23
CX-WM-1/2VC	29	SF-3PVC	44	WB-HS-BKG	19	WE-LAV-WM-LBO-S	23
CX-WM-3/4VC	29	SF-4RND	44	WB-HS-WM-HS	27	WE-LAV-WM-WF	23
CX-WM-DIV	29	SF-4SQ	44	WB-HS-WM-THERM	27	WE-PB	24
DRAIN-BAR	42	SF-5SQ	44	WB-LAV-DM-LBO-S	6	WE-RTF-DM-GN	22
DRAIN-EXT	43	SF-6RND	44	WB-LAV-DM-LBO-T	6	WE-RTF-DM-LBO-S	22
DRAIN-FT	43	SF-6SQ	44	WB-LAV-DM-WF-S	4	WE-RTF-DM-LBO-T	22
DRAIN-GR	43	SF-CI	44	WB-LAV-DM-WF-T	4	WE-RTF-DM-WF	22
DRAIN-ST	43	SHW-WATTS	24	WB-LAV-WM-LBO	6	WE-RTF-WM-7	23
DRAIN-TAIL	43	ST-10-105	32	WB-LAV-WM-WF	4	WE-RTF-WM-7-SPOUT	24
DRAIN-TRAP	43	ST-10-124	32	WB-RTDO	43	WE-RTF-WM-9	23
FINISH SAMPLES	45	ST-10-132	32	WB-RTF-DM-LBO	7	WE-RTF-WM-LBO-L	23
HS-WM-SB	19	ST-10-135	32	WB-RTF-DM-WF	5	WE-RTF-WM-LBO-S	23
NIPPLE-3/4-12	45	ST-10-361	32	WB-RTF-FM-LBO	7	WE-RTF-WM-LBO-S-SPOUT	24
POU-GN-C	41	ST-ACC-RH	30	WB-RTF-FM-LBO-CSTM	7	WE-RTF-WM-WF	23
POU-GN-H	41	ST-ACC-TB	30	WB-RTF-FM-LBO-HS	7	WE-RTF-WM-WF-SPOUT	24
POU-GN-HC	41	ST-ACC-TP	30	WB-RTF-FM-WF	5	WE-THERM	24
POU-LBO-C	41	ST-DM-DIV	31	WB-RTF-FM-WF-CSTM	5	WE-TRIM-RING	26
POU-LBO-H	41	STEM-EXT	45	WB-RTF-FM-WF-HS	5	WE-WM-1/2VC	24
POU-LBO-HC	41	ST-LAV-DM	30	WB-RTF-WM-LBO	7	WE-WM-3/4VC	24
SANS-AC-ADAPTER	34	ST-LAV-WM-L	30	WB-RTF-WM-LBO-HS	7	WE-WM-DIV	24
SANS-CX-DM-S	34	ST-LAV-WM-S	30	WB-RTF-WM-WF	5	WN-GN-FX	39
SANS-CX-DM-T	34	ST-PB	31	WB-RTF-WM-WF-HS	5	WN-GN-LG	39
SANS-CX-WM	35	ST-RTF-DM	30	WB-SCREWS	45	WN-GN-LG-W/SP	39
SANS-ST-DM	34	ST-RTF-WM-L	30	WB-SHW-140	16	WN-GN-SW	39
SANS-ST-WM	35	ST-RTF-WM-S	30	WB-SHW-150	16	WN-GN-W/SP	39
SANS-WE-DM-GN	34	ST-THERM	31	WB-SHW-170	16	WN-SP	39
SANS-WE-DM-LBO-S	34	ST-WM-1/2VC	31	WB-SHW-180	16	WN-SQ-FX	39
SANS-WE-DM-LBO-T	34	ST-WM-3/4VC	31	WB-SHW-1040	9	WN-SQ-SW	39
SANS-WE-DM-WF	34	ST-WM-DIV	31	WB-SHW-1050	9	WN-SQ-W/SP	39
				WB-SHW-1070	9		

SONOMA FORGE TERMS & CONDITIONS

PRICING

All product prices include valve(s) and trim(s). Unless otherwise noted, all products are priced individually. Most lavatory faucet kits include one matching drain. The drain style may vary unless specified on your order. Duties, taxes, storage, payment processing fees, etc., are not included.

SHIPPING

Shipping to addresses in the "Lower 48 States" qualify for **free ground shipping**. Shipping charges for Hawaii, Alaska, and international shipments will be invoiced at a discounted rate. Please contact Sonoma Forge for shipping quotes.

Additional charges apply for drop-shipping, lift gate, limited access, weekend delivery, and changes to delivery.

CLAIMS

All orders must be inspected upon receipt. Damage and/or discrepancies must be reported to Sonoma Forge within three (3) business days of delivery, and before product leaves the original delivery address.

Packaging with visible damage should be noted with the delivery driver.

Packages should be refused if product damage is obvious from the outside of damaged and/or open packaging.

Sonoma Forge is not liable for lost or damaged product that was drop-shipped. The dealer takes full responsibility for any drop-shipped product after it has left Sonoma Forge.

RETURNS & CANCELLATIONS

No returns will be accepted without prior authorization from Sonoma Forge.

Sonoma Forge is not responsible for any labor, packaging, shipping costs or damage of returning product.

Restocking fees will be assessed based on several conditions, not limited to:

- Date of original invoice:
 - Up to 30 days: 25%
 - 31 to 60 days: 35%
 - 61 to 90 days: 50%
 - 91+ days: negotiable
- Used, damaged, and custom products are not returnable.

Order cancellations are only accepted by email, and are subject to a fee of up to 75%.

WARRANTY

Sonoma Forge products are assembled and finished by hand in the USA. Each part is unique and individual, and may vary slightly from one part to another. We warrant the quality of our products to be free of manufactured defects and will repair any defective product up to **five years** from purchase date. Product will be replaced if not repairable, at the discretion of Sonoma Forge.

- Replacement parts may not be available after two years of purchase.
- Products installed outdoors do not qualify for complete warranty.
- Damage from freezing temperatures or other weather conditions is not covered under warranty.

Sonoma Forge shall not be responsible or held liable for labor, installation, removal, or shipping charges; consequential, incidental, indirect, special, economic, or punitive damages; as well as illness injury, disability, or death from installation, handling, or use of our products.

CARE & MAINTENANCE

Wipe with a clean, soft, damp cloth. Mild soap may be used. Blot dry.

100% carnauba wax can be used properly to protect finishes.

For information or parts not listed in our price book, please contact Sonoma Forge.



SONOMA FORGE
DESIGNER FAUCETS

